

ABCO 2 Section Cardiac / Ultrasound / Imaging Couch



The ABCO Cardiac / Ultrasound / Imaging Couch, developed and manufactured in Australia, is designed to handle patients up to 300kg with a clean, uncluttered structure.

It features a cardiac cut-out that drops down for unhindered access to the torso, enhancing patient care.

The two-column structure improves safety by reducing the risk of fingers or limbs getting caught. With a minimum height of 51cm, it ensures easy access for frail or disabled patients.

The braked castor system allows for easy movement without compromising stability. Additionally, the height, $\pm 15^\circ$ Trendelenburg, and backrest are all electrically adjustable using a foot control, leaving both hands free for treatment.

The robust structure, capable of supporting up to 300kg, ensures a long, trouble-free life, making it a reliable choice for medical settings.

Factory Fitted Options

- Choice of upholstery colours

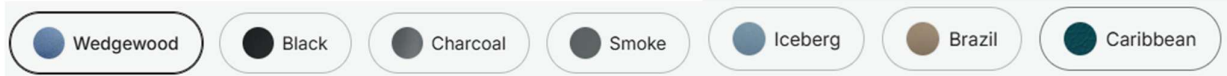







- Increase width to 800mm
- Central locking wheel system



Add-ons

Useful additions to your table which can be factory installed when ordering or after purchase with minimal DIY required.

					
Upholstered Cot Side	Gas lift stool	Back-up Battery	Removeable battery	Paper Towel Roll Holder	Hand Control and Wireless Controls

See full details [here](#) or follow the QR code



Standard Specifications

SKU: EH2C.07121.TE000F.005P0

Dimensions and Adjustment

Height Adjustment Control - Foot control

Height Adjustment Lift Operation - Twin electric column for extra strength and safety with no longitudinal shift as height adjusts

Maximum Lifting Capacity - 300kg Dynamic / 600kg Static

Height Adjustment Range - 510 - 910mm

Overall Upholstery Width - 710mm

Upholstery Adjustment

Backrest - 680mm long with cardiac cut-out - Electric - -0° / $+80^{\circ}$

Long Section - 1220mm long

Trendelenburg - $\pm 15^{\circ}$

Frame

Frame - 3 Stage Powdercoated Steel

Wheel System - 125mm Thermoplastic heavy duty, lockable castors

Upholstery

Fabric - Medical grade fabric with Ezyclean. Resistant to Isopropyl Alcohol and bleach based cleaners

Foam - 50mm medium density foam

Colours - 15 Colours available

Electrical Requirements

Approvals - Medically approved according to EN60601-1/ AS3200

Supply - Domestic 10Amp or equivalent

General

Shipping Dimensions - 197 x 82 x 65cm / 95kg. Shrink-wrapped on a wooden pallet

Weight - 80kg

ARTG - 123573

Warranty - 5 years

Conditions of sale available online

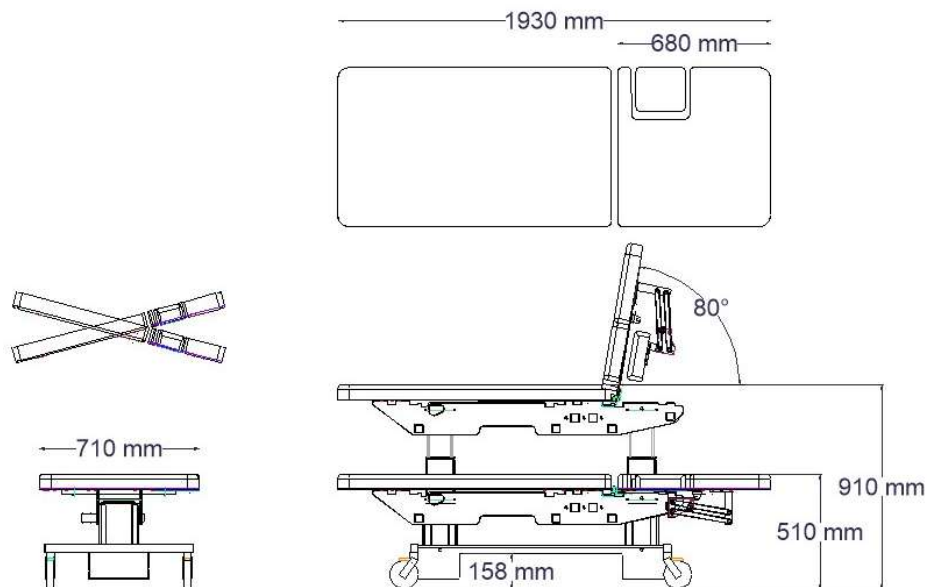

ABCO Health Care is a specialist manufacturer of electrically operated couches, tables and chairs for health care applications.

This brochure shows only part of our extensive range. Please visit our web site at www.abcohc.com.au

ABCO Health Care has a policy of continuous improvement. All specifications and prices are subject to change without notice.

ABCO Health Care Pty Ltd

A.B.N. 71 073 519 356

Australian Designed, Made and Owned.

3-7 Discovery Road, Dandenong South

Victoria 3175, Australia

Phone +61 03 97683756

E-mail: sales@abcohc.com.au