

## ABCO Exam G Couch



ABCO Health Care Height Adjustable 2 section Exam G general purpose gynaecology couches are designed and manufactured in Australia.

The low minimum height makes access for frail or disabled patients easy and the maximum height is high enough for tallest carers to work comfortably.





A perineal cut-out and adjustable foot pads help with patient comfort and clinician access.

A comprehensive range of factory fitted options including lithotomy knee supports allows you to specify the best configuration for your requirements.

- [Trendelenburg to 15° option also available]

Product Code: **GYE20.07121.CE000H.005P0**

Standard Configuration	Factory Fitted Options
Hand control	Foot control
	Twin foot or hand control
	Add Breathe Hole with plug in backrest
	Add Battery
Single Backrest	Twin Backrest

Accessories	
Cot Sides [either or both sides]	
Gynaecological under-knee supports	
Height adjustable / removable arm rests	
Treatment Arm Board	
Gas lift stool upholstered to match your couch	

## Detailed Standard Specification

Couch Dimensions	Backrest	680mm long
	Main Section	1220mm long
	Overall Length	1930mm
	Width	710mm
Upholstery Angle adjustment	Backrest	Electric
Upholstery	Fabric	Vinyl – Medical grade heavy duty vinyl fabric. Formulated to inhibit hardening and breakdown of the PVC surface due to perspiration and oils. Light fast, fire retardant, sanitised and stain resistant.
	Foam	38mm high density foam rolled over the edges of the strong plywood base covered with 12mm of soft foam for enhanced comfort while providing a full working width and extended life.
	Colours	Wedgewood. Other colours on request
Frame	Materials	Heavy steel plate and tube
	Colour	Light Grey
	Wheel System	125mm Braked castors for easy movement. One castor has a tracking lock while the other three have a total lock facility.
Height adjustment	Range	500 – 900mm
	Lift mechanism	Two column for extra strength and safety with no longitudinal shift as height adjusts
	Lift operation	Linak brand European electric columns
	Control	Hand control
Electrical Requirements		Medically approved to AS 3200 / EN60601 - 1
	Supply	230vAC $\pm 10^\circ$ , 50hz max 1.5amp
	Operation	24vDC max 70VA
Lifting Capacity		300+kg
Weight		80kg
Shipping Dimensions		197 x 73 x 60cm / 90kg. Shrink-wrapped on a wooden pallet
ARTG No		123753
Warranty		5 years, parts only

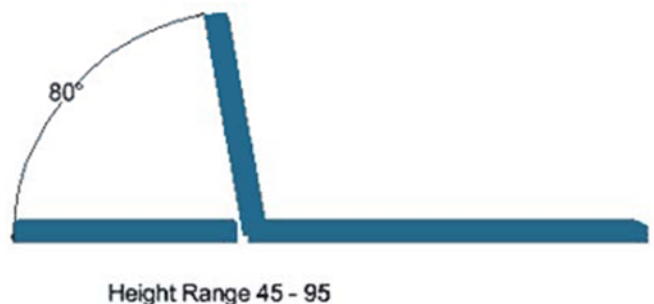
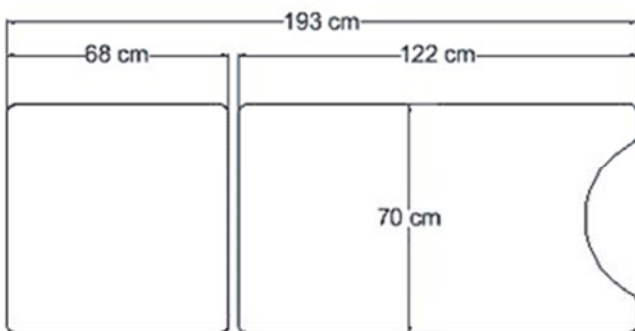

ABCO Health Care is a specialist manufacturer of electrically operated couches, tables and chairs for health care applications.

This brochure shows only part of our extensive range. Please visit our web site at [www.abcohc.com.au](http://www.abcohc.com.au)

ABCO Health Care has a policy of continuous improvement. All specifications and prices are subject to change without notice.

**ABCO Health Care Pty Ltd**

A.B.N. 71 073 519 356

Australian Designed, Made and Owned.

3-7 Discovery Road, Dandenong South  
Victoria 3175, Australia

Phone +61 03 97683756

E-mail: [sales@abcohc.com.au](mailto:sales@abcohc.com.au)