

ABCO 2 Section Examination Couch



ABCO Health Care Height Adjustable 2 section Examination couches are designed and manufactured in Australia to match the recommendations of the RACGP.

As such, they are long enough and wide enough for most patients. The minimum height of just 45cm makes access for frail or disabled patients easy and the maximum height of 95cm is high enough for tallest carers to work comfortably.





A comprehensive range of factory fitted options allows you to specify the best configuration for your requirements.

Accessory cot sides and gynaecological stirrups can also be fitted

The retractable wheel system makes moving the couch easy without compromising stability in use.

Product Code: **EX20.07121.EM000H.00W10**

Standard Configuration	Factory Fitted Options
710mm wide Upholstery	600mm wide upholstery
Retractable castors	75mm braked castors
Manual Upholstery adjustment	Electric Backrest [with hand control]
Hand control	Foot control
	Twin foot or hand control
	Add Breathe Hole with plug in backrest
	Add Battery
	Add Paper Towel Roll [600mm] Holder

Accessories	
Cot Sides	
Gynaecological under-knee supports	
Height adjustable / removable arm rests	
Treatment Arm Board	
Gas lift stool upholstered to match your couch	

Detailed Standard Specification		
Couch Dimensions	Backrest	680mm long
	Main Section	1220mm long
	Overall Length	1930mm
	Width	710mm
Upholstery Angle adjustment	Backrest	Manual [rods through plates]
Upholstery	Fabric	Vinyl – Medical grade heavy duty vinyl fabric. Formulated to inhibit hardening and breakdown of the PVC surface due to perspiration and oils. Light fast, fire retardant, sanitised and stain resistant.
	Foam	38mm high density foam rolled over the edges of the strong plywood base covered with 12mm of soft foam for enhanced comfort while providing a full working width and extended life.
	Colours	Wedgewood. Other colours on request.
Frame	Materials	Heavy steel plate and tube
	Colour	Light Grey
	Wheel System	Single action retractable castors for ease of movement and 'on-the-floor' stability in use. Levelling foot on one corner.
Height adjustment	Range	450 – 950mm
	Lift mechanism	Two leg swing arm
	Lift operation	Linak brand European electric actuator
	Control	Hand control
Electrical Requirements		Medically approved to AS 3200 / EN60601 - 1
	Supply	230vAC $\pm 10^\circ$, 50hz max 1.5amp
	Operation	24vDC max 70VA
Lifting Capacity		200kg
Weight		70kg
Shipping Dimensions		197 x 73 x 60cm / 95kg. Shrink-wrapped on a wooden pallet.
ARTG No		123753
Warranty		5 years, parts only

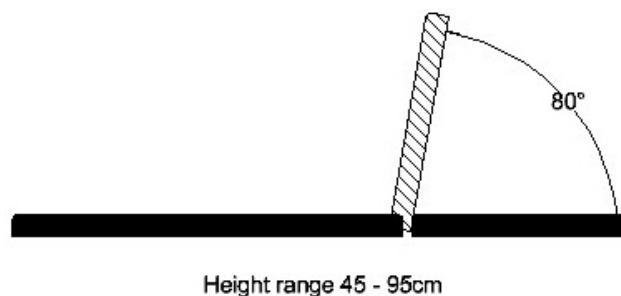
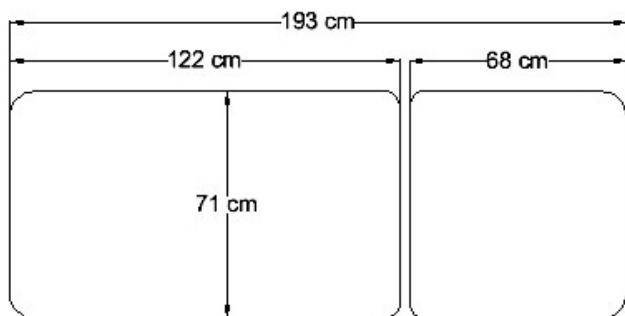

ABCO Health Care is a specialist manufacturer of electrically operated couches, tables and chairs for health care applications.

This brochure shows only part of our extensive range. Please visit our web site at www.abcohc.com.au

ABCO Health Care has a policy of continuous improvement. All specifications and prices are subject to change without notice.

ABCO Health Care Pty Ltd

A.B.N. 71 073 519 356

Australian Designed, Made and Owned.

3-7 Discovery Road, Dandenong South
Victoria 3175, Australia

Phone +61 03 97683756

E-mail: sales@abcohc.com.au